

# WOODEN GATES

## SPECIFICATION SHEET

- High quality prepared softwood drive/field gate
- Full width heavy top rail for added strength
- Pressure treated with Tanalith E for maintenance free longevity
- Slow grown selected Redwoods
- All softwood gates conform to BS370
- Zinc coated fixings available

Available in 13 widths, starting at 0.90m up to 4.50m

### Features







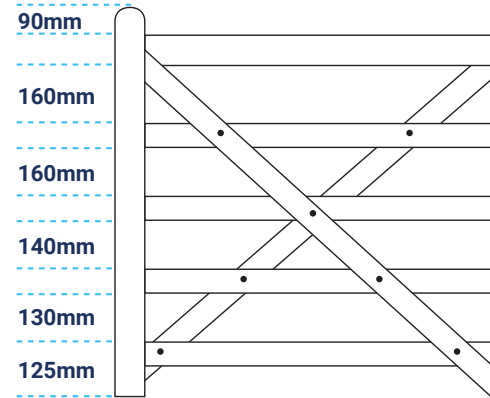
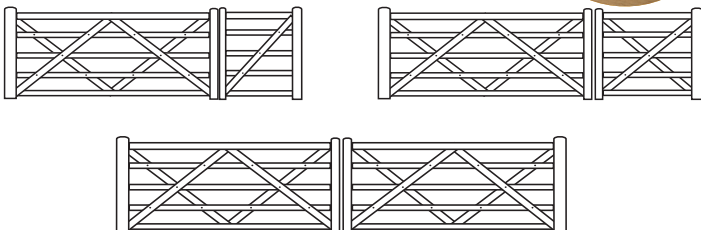

- These high specification traditional 5 bar design wooden gates are made from kiln dried Scandinavian Redwood
- Features a heavy solid top rail ex100mm x 75mm for the entire width of the gate for added strength. The popular diamond braced design also gives added strength to the gate
- Morticed rails and cross bracing ex75mm x 25mm are all held together with zinc coated nuts and bolts
- The hanging headstock stile is ex125mm x 75mm with an ex75mm x 75mm closing stile, both with rounded tops
- Height to top of hanging stile is 1.2m (47"). Standard sizes range from 0.9m (3") to 4.57m (15")
- Full range of fittings and posts to suit various options stocked

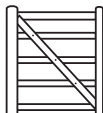
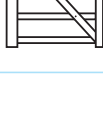
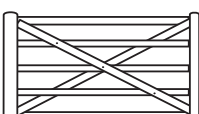
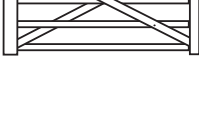
### How to identify left or right hand gates?

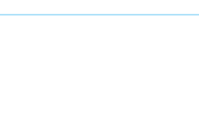
When viewed from the road side the hanging stile will be either on the left or right hand side, bolt heads facing the road

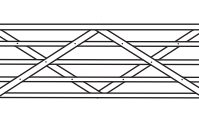
### Pair them up



Width	Height	Pattern	Code
0.90m	1.2m		<b>Softwood: WG703</b>
1.20m	1.2m		<b>Softwood: WG704</b>
1.50m	1.2m		<b>Softwood: WG705</b>
1.80m	1.2m		<b>Softwood: WG706</b>
2.10m	1.2m		<b>Softwood: WG707</b>
2.40m	1.2m		<b>Softwood: WG708</b>
2.70m	1.2m		<b>Softwood: WG709</b>
3.00m	1.2m		<b>Softwood: WG710</b>
3.30m	1.2m		<b>Softwood: WG711</b>
3.60m	1.2m		<b>Softwood: WG712</b>
3.90m	1.2m		<b>Softwood: WG713</b>
4.20m	1.2m		<b>Softwood: WG714</b>
4.50m	1.2m		<b>Softwood: WG715</b>

*Diagrams are left handed*

### Alternative options

- Heavy bottom rail and 6 rail options available
- Heavy bottom rail to suit electric gate installations
- 6 rail option to suit those with dogs
- Hardwood timber option available in all designs

Available in 10 widths, starting at 0.90m up to 3.60m

### Features

- Heavy solid top rail ex90mm x 70mm PAR for the entire width of the gate for added strength. The popular diamond braced design also gives added strength to the gate
- Morticed rails and cross bracing ex70mm x 20mm are all held together with zinc coated nuts and bolts
- Stiles are 95mm x 70mm both with rounded tops
- Heavy bottom rail 70mm x 70mm PAR
- Height to top of hanging stile is 1.2m (47"). Standard sizes range from 0.9m (3") to 4.57m (15")
- Full range of fittings and posts to suit various options stocked

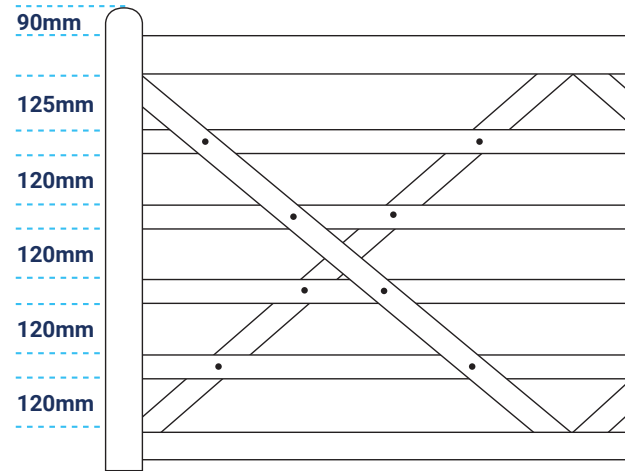

Heavy Bottom Rail



ADDED STRENGTH



ADDED SECURITY  
for dogs & lambs

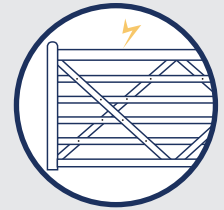

ELECTRIC GATE

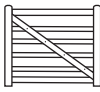
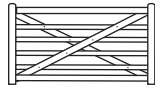
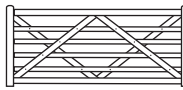

Width	Height	Pattern	Code
0.90m	1.2m		WG703HBR
1.20m	1.2m		WG704HBR
1.50m	1.2m		WG705HBR
1.80m	1.2m		WG706HBR
2.10m	1.2m		WG707HBR
2.40m	1.2m		WG708HBR
2.70m	1.2m		WG709HBR
3.00m	1.2m		WG710HBR
3.30m	1.2m		WG711HBR
3.60m	1.2m		WG712HBR

Copyright © 2020 McVeigh Parker. All Rights Reserved.